



Conveying Solutions *Timing Belts*





IT'S ALL A MATTER OF TIMING...

➔ The open-end timing belts are a perfect choice for applications requiring a great degree of flexibility for synchronous conveying and linear positioning. Volta manufactures linear timing belts in a variety of tooth types, pitches and lengths. Nylon fabric facing on teeth is also available. Our timing belts are typically sold in open-ended lengths and may be supplied endless upon request. The belt is made endless using a Finger Splicing method. We offer you the ideal package of open-end timing belts that incorporate the quality character features of perfectly formed teeth, accurate pitch tolerances and steel cord reinforcement. These special Volta characteristics provide a positive-drive mechanism and ensure accurate product placement. The TPE material composition provides superior wear, is abrasion resistant and can be easily fabricated.

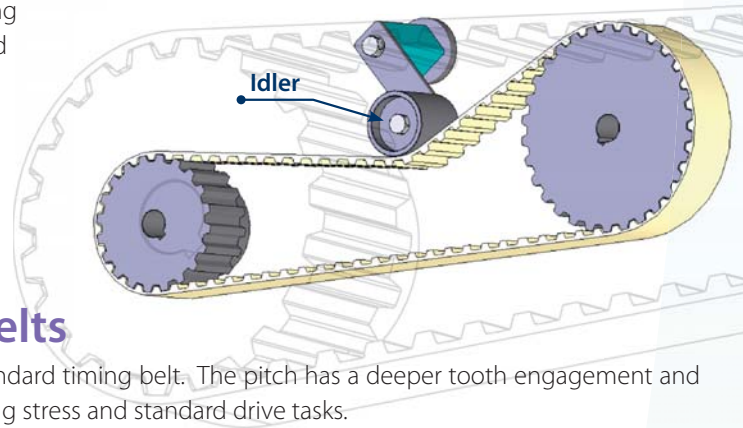

"T" Metric Pitch Open-End Timing Belts

The trapezoidal profile of the belts is considered to be the classic standard timing belt. The pitch has a deeper tooth engagement and tooth meshing is more reliable. "T" belts are designed for high bending stress and standard drive tasks.

➔ Product: "T" Metric Pitch Open-End Timing Belts

Description & Color: Steel Reinforced, White
Shore Hardness: 92A
Temp. Range: -10° C to +80° C

Belt Type	P(mm)	$\beta(^{\circ})$	T(mm)	H(mm)
T5	5	40	1.2	2.2
T10	10	40	2.5	4.5
T20	20	40	5	8

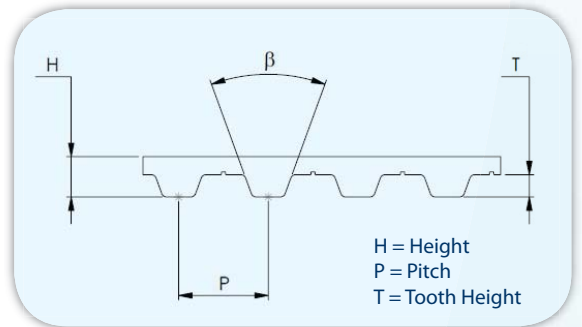

Belt Type	Standard Max. Width (mm)	Width Tolerance +/- (mm)		Standard Rolls Length (m)
		Belt Width \leq 50	Belt Width $>$ 50	
T5	100	0.5	0.75	50
T10	150	0.5	0.75	50
T20	150	1	1	50

Minimum Number of Teeth & Pulley Diameter

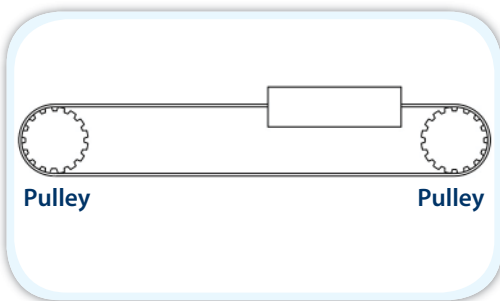

Drive Without Idler

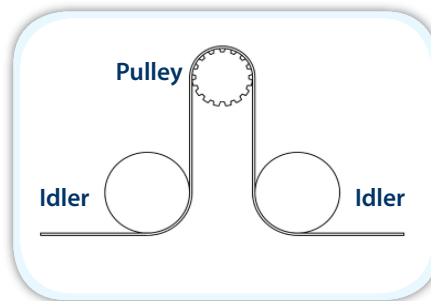

Flat idler on belt back

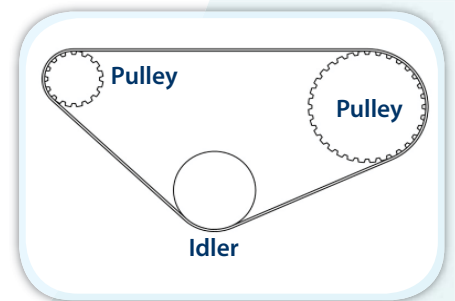

Flat idler on belt teeth

Belt Type	Z Min (# of Teeth)
T5	10
T10	12
T20	15

Z Min (# of Teeth)	Flat idler on belt back min. diameter (mm)
15	30
20	60
25	120

Z Min (# of Teeth)	Flat idler on belt teeth min. diameter (mm)
10	30
12	60
15	120

Note: Additional width can be supplied upon request. For additional spliced width please contact your local supplier.



“AT” Metric Pitch Open-End Timing Belts

The teeth have a larger tooth volume and stronger tension members. Its design is ideal for linear positioning and motion control. They also enable higher load carrying capacity, low backlash, pitch accuracy and a high breaking load.

Product: “AT” Metric Pitch Open-End Timing Belts

Description & Color: Steel Reinforced, White

Shore Hardness: 92A

Temp. Range: -10° C to +80° C

Belt Type	P(mm)	β (°)	T(mm)	H(mm)
AT5	5	50	1.2	2.7
AT10	10	50	2.5	4.5
AT20	20	50	5	8

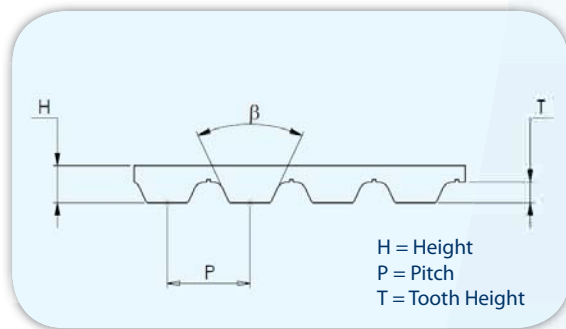

Belt Type	Standard Max. Width (mm)	Width Tolerance +/- (mm)		Standard Rolls Length (m)
		Belt Width \leq 50	Belt Width $>$ 50	
AT5	100	0.5	0.75	50
AT10	150	0.75	1	50
AT20	200	1	2	50

Minimum Number of Teeth & Pulley Diameter

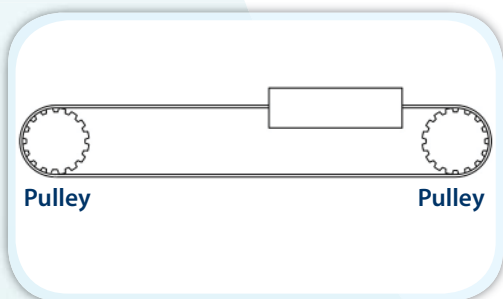

Drive Without Idler

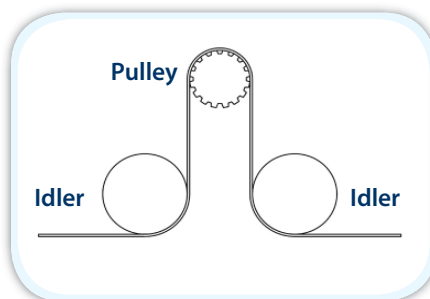

Flat idler on belt back

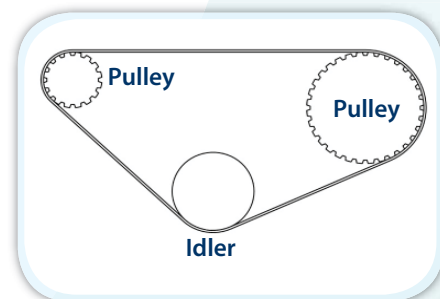

Flat idler on belt teeth

Belt Type	Z Min (# of Teeth)
AT5	15
AT10	15
AT20	18

Z Min (# of Teeth)	Flat idler on belt back min. diameter (mm)
25	60
25	120
25	180

Z Min (# of Teeth)	Flat idler on belt teeth min. diameter (mm)
15	25
15	50
18	120

Note: Additional width can be supplied upon request. For additional spliced width please contact your local supplier.



“HTD” Metric Pitch Open-End Timing Belts

Due to the round tooth design, these belts offer a perfect tooth meshing performance, optimized force and load distribution. HTD belts are ideal for linear and rotary positioning applications.

➔ Product: “HTD” Metric Pitch Open-End Timing Belts

Description & Color: Steel Reinforced, White

Shore Hardness: 92A

Temp. Range: -10° C to +80° C

Belt Type	P(mm)	β (°)	T(mm)	H(mm)
HTD5	5	N/A	2.1	3.6
HTD8	8	N/A	3.4	5.6
HTD14	14	N/A	6.1	10

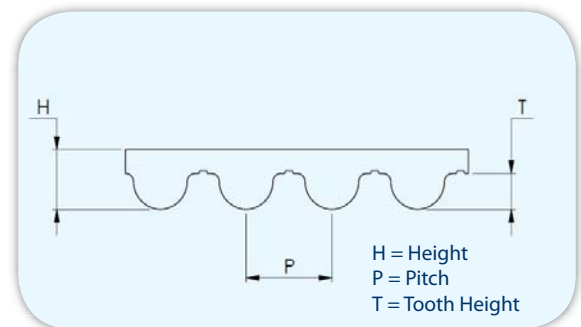

Belt Type	Standard Max. Width (mm)	Width Tolerance +/- (mm)		Standard Rolls Length (m)
		Belt Width <= 50	Belt Width > 50	
HTD5	100	0.5	0.75	50
HTD8	150	0.75	1	50
HTD14	200	1	2	50

Minimum Number of Teeth & Pulley Diameter

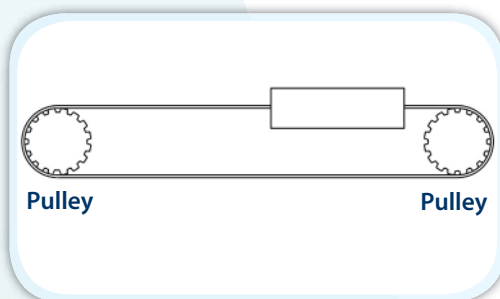

Drive Without Idler

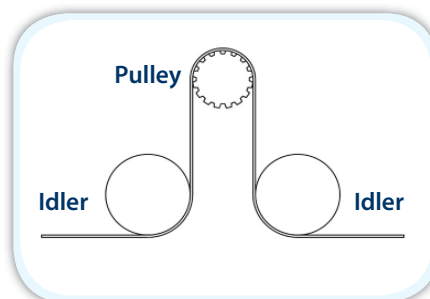

Flat idler on belt back

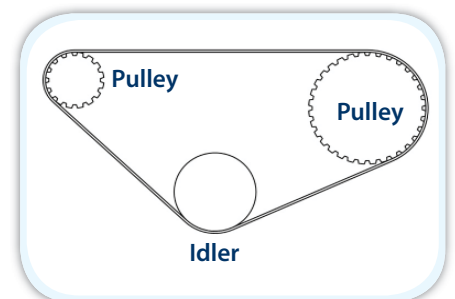

Flat idler on belt teeth

Belt Type	Z Min (# of Teeth)
HTD5	16
HTD8	20
HTD14	26

Z Min (# of Teeth)	Flat idler on belt back min. diameter (mm)
16	50
22	100
28	180

Z Min (# of Teeth)	Flat idler on belt teeth min. diameter (mm)
16	25
20	50
26	120

Note: Additional width can be supplied upon request. For additional spliced width please contact your local supplier.

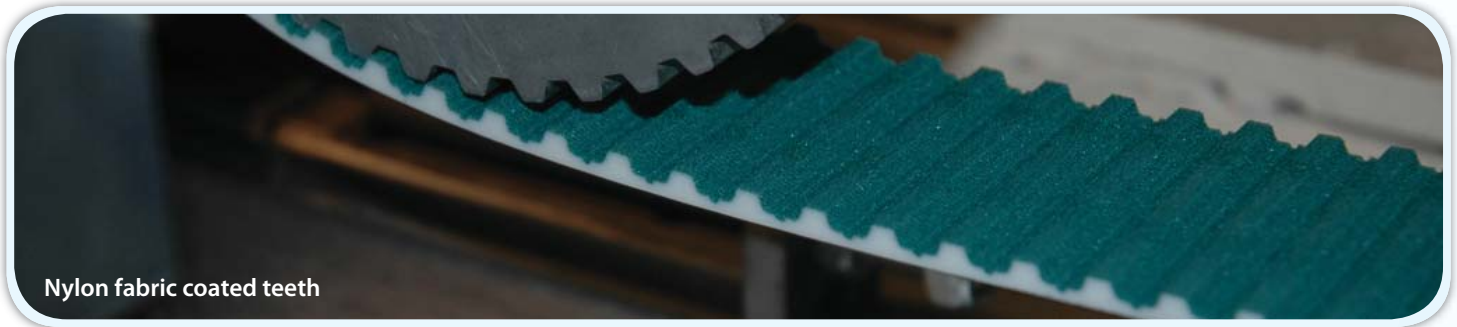

Nylon fabric coated teeth

Imperial Pitch Open-End Timing Belts

The tooth profile of these belts is fairly low and has a large surface area at the tip of the tooth providing good support on sliding conveyor surfaces. The tooth design is similar to the "T" belt series.

Product: "Imperial" Metric Pitch Open-End Timing Belts

Description & Color: Steel Reinforced, White

Shore Hardness: 92A

Temp. Range: -10° C to +80° C

Belt Type	P(mm)	β (°)	T(mm)	H(mm)
XL	5.08	50	1.27	2.3
L	9.525	40	1.91	3.6
H	12.7	40	2.29	4.3
XH	22.225	40	6.35	11.2

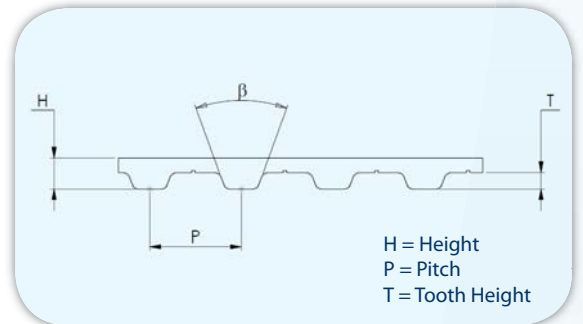

Belt Type	Standard Max. Width (inch.)	Width Tolerance +/- (mm)		Standard Rolls Length (m)
		Belt Width \leq 50	Belt Width $>$ 50	
XL	4	0.5	0.75	50
L	4	0.5	0.75	50
H	6	0.5	0.75	50
XH	6	1	1	50

Minimum Number of Teeth & Pulley Diameter

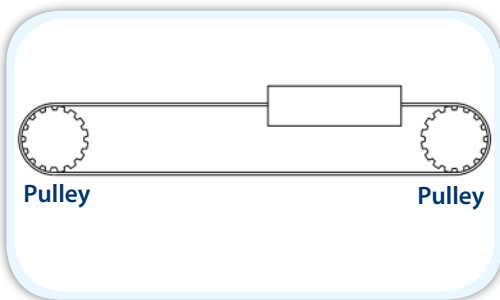

Drive Without Idler

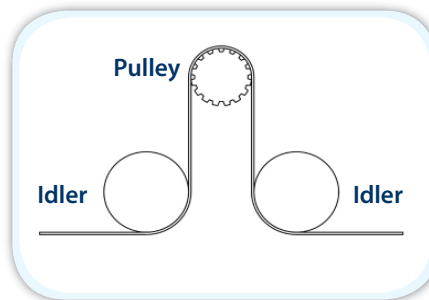

Flat idler on belt back

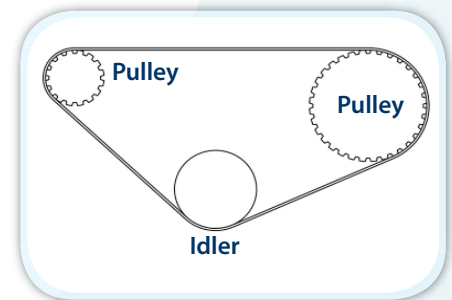

Flat idler on belt teeth

Belt Type	Z Min (# of Teeth)
XL	10
L	15
H	14
XH	18

Z Min (# of Teeth)	Flat idler on belt back min. diameter (mm)
15	30
20	60
20	80
20	120

Z Min (# of Teeth)	Flat idler on belt teeth min. diameter (mm)
10	30
15	60
14	80
18	150

Note: Additional width can be supplied upon request. For additional spliced width please contact your local supplier.

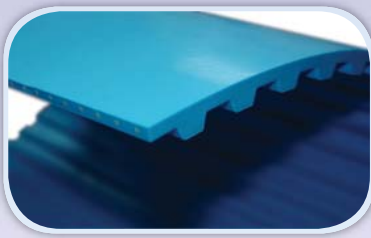

Food Approved Timing Belt

Volta Food Approved (FDA) TPE Linear Timing Belts are made with completely sealed aramid cord reinforcement. This special feature eliminates any contact between cord and the product being conveyed and increases hygiene levels when used in wet or dry food applications. The material character of this belt is ideal for strong heat welded fabrications and coatings.



Food Approved Timing Belts				
Products	Color	Hardness	Temperature Range	FDA
T10	Blue	92A	0° C to +80° C	Yes

Notes: *For additional pitch sizes please ask your local Volta representative.

→ Volta TPE Timing belts are most compatible for heat welded fabrications, achieving a superior bond and easily reaching a broad range of unique design challenges.

Coatings

Speciality coatings can be fabricated when specific surface characteristics are required. The full range of Volta Coating materials (see our "Belt Coating Materials" flier) can be easily heat welded to all of our Timing Belts. These coatings provide a soft, high grip over the Timing belt surface and are highly resistant to cuts and abrasion. The Volta green Foam coating acts as a firm cushioning and provides a tougher high friction outer layer.

Our Timing belts can also be effectively coated with the Volta high quality flat belt material available in a wide range of Shore Hardnes (M = 95A, L = 80A, ST = 62A, PZ = 86A, etc.) offering different coefficients of friction as needed. Volta's Impression- and Special- textured top belts (Spikes, Crescent Top, Impression Roof Top, Mini Cleats, Supergrip, etc.) in combination with our Timing belts can be the perfect solution for all of your special applications.

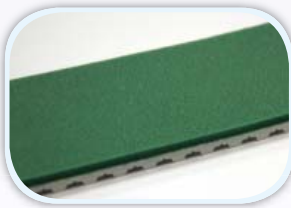

Foam coating

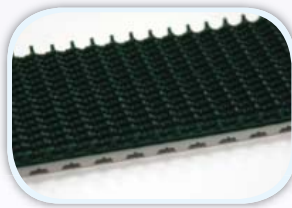

SuperGrip coating



Spike coating



Food Approved High Grip

Flight (Cleats)

Our Flat belts made of Volta M and L materials can be used as flights/cleats on our Timing belts. V profiles, Soft guides and Special profiles can also be heat welded onto timing belts for flights to suit your particular application needs. The teeth can be covered by using colored Nylon fabric upon request in order to reduce the noise level and to lower the friction of the timing belt.



↓

For any technical questions & additional information please contact your Volta representative or email to sales@voltabelting.com

**Corporate Headquarters
Sales and Manufacturing**
sales@voltabelting.com

USA
Tel: +1 973 276 7905
Fax: +1 973 276 7908
Toll Free: 1-877-VOLTAUS

EUROPE
Tel: +31-546-580166
Fax: +31-546-579508

www.voltabelting.com
e-mail: sales@voltabelting.com